

Store bateau motorisé

ATF35-RS



- Store bateau motorisé avec un design compact.
- Idéal aussi bien pour l'équipement professionnel que résidentiel : L 2500 x H 3000 mm, 8 m².

ATF35-RS

ATF35-RB Caractéristiques

Store bateau motorisé, compact et design, idéal pour l'équipement professionnel et résidentiel.

Moteur silencieux.

Schéma détaillé

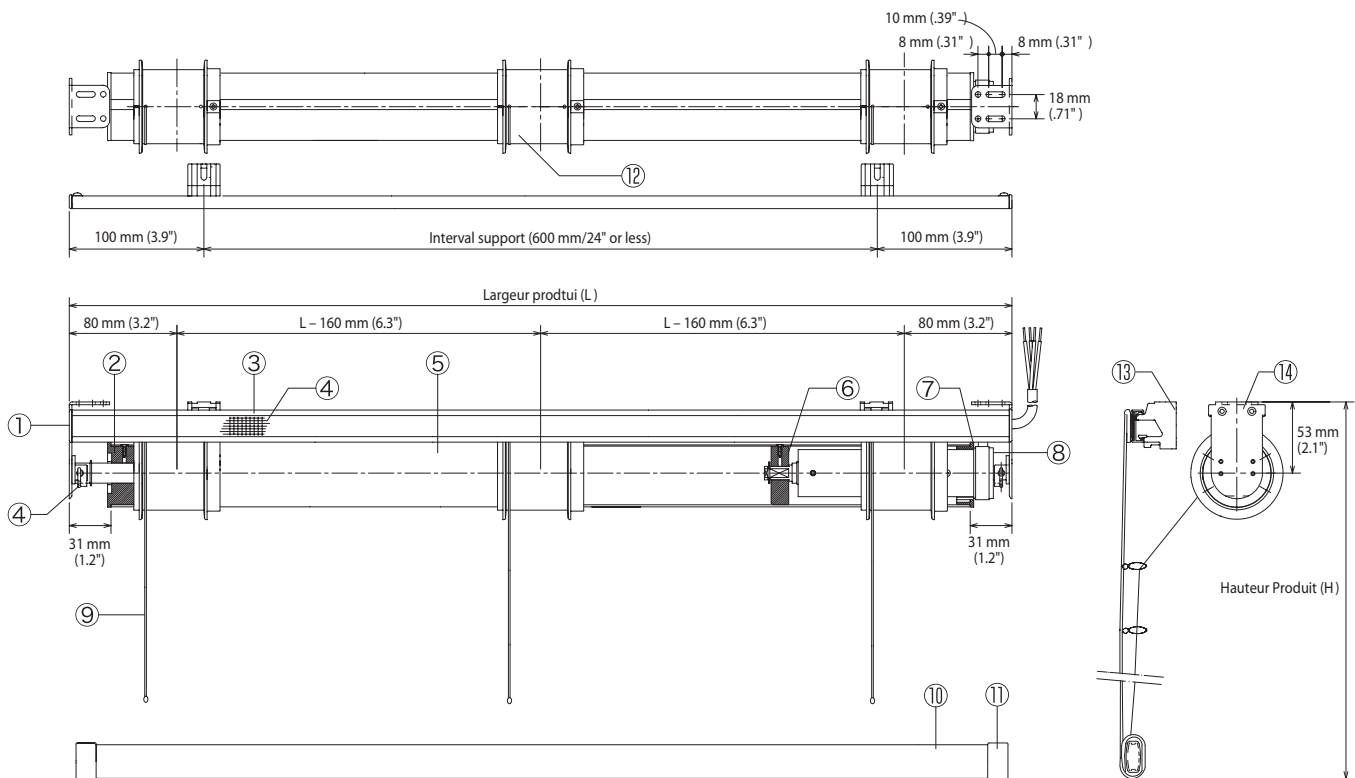

Composants et matériaux

No.	Composants	Matériau
①	Freel Embout	Résine polycétale
②	ATF35 Embout	Résine polycétale
③	Freel profil	Aluminum
④	Ruban agrippant	Polypropylene
⑤	ATF35 Tube ø 50 mm	Aluminum
⑥	ATF35 Couronne moteur	Résine polycétale
⑦	ATF35 Couronne guide	Résine polycétale

No.	Composants	Matériau
⑧	ATF35 Moteur	—
⑨	Cordon d'élévation ø 1.2 mm	Polystère
⑩	Barre de charge	Acier
⑪	Embout barre de charge	Résine polyéthylène
⑫	ATF35-RS Bobine	Résine polycétale
⑬	Freel Support	Résine polycétale
⑭	ATF35 Support	Acier inoxydable

Caractéristiques moteur

Alimentation	V	AC220 ±10%
Fréquence	Hz	50 /60
Ampérage	A	0.6
Consommation	W	115
Couple	Nm	4
Rotation	rpm	23/27
Temps de fonctionnement continu	min	4
Température de sécurité	°C	-10-60

Dimensions

Largeur	850-2000 mm (33-79")
Hauteur	600-3000 mm (24-118")
Surface maximum	6 m ² (7.2 yd ²)

Poids maximum du tissu

6.0 kg (13 lb)
(1.0 kg/2 lb max. par bobine)

Poids produit

5.0 kg (11 lb)
(largeur: 2000 mm/79" sans tissu)

Nombre de cordon d'élévation recommandé

Largeur produit	800-900 mm (32-35")	910-1400 mm (36-55")	1410-1900 mm (56-75")	1910-2000 mm (75-79")
Nombre de cordon	3	4	5	6

Largeur plis

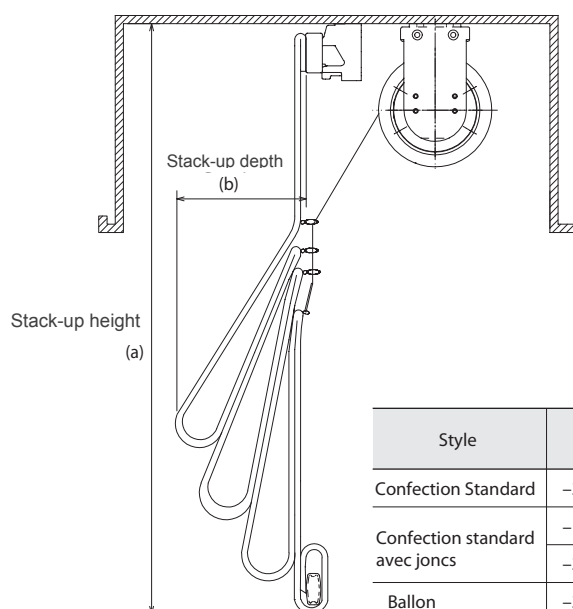

Style	Hauteur Produit	Interval anneaux recommandé	Largeur plis Dimension (a)	Largeur plis Dimension (b)
Confection Standard	-3000 mm (118")	200 mm (7.9")	228 mm (9.0") + H/80 mm (3.2")	80 mm (3.2")
Confection standard avec joncs	-1500 mm (59")	120 mm (4.7")	243 mm (9.6") + H/24 mm (.94")	100 mm (3.9")
	-3000 mm (118")	150 mm (5.9")	273 mm (10.8") + H/30 mm (1.2")	
Ballon	-3000 mm (118")	150 mm (5.9")	603 mm (24") + H/60 mm (2.4")	200 mm (7.9")

Schéma général de pose

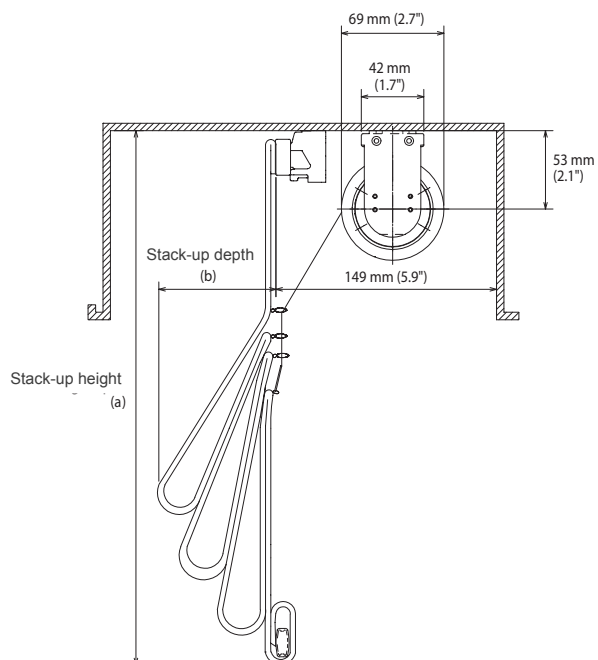
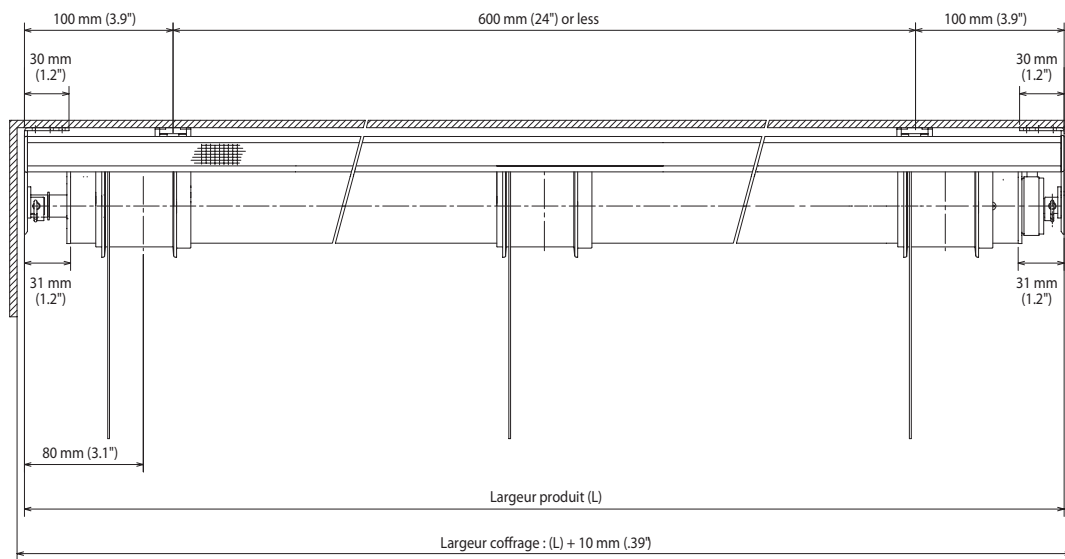
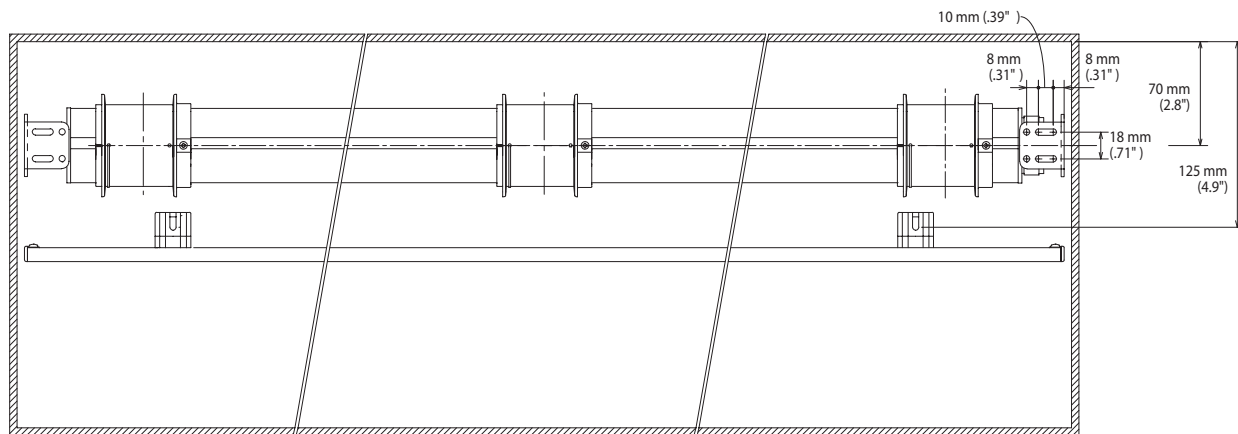



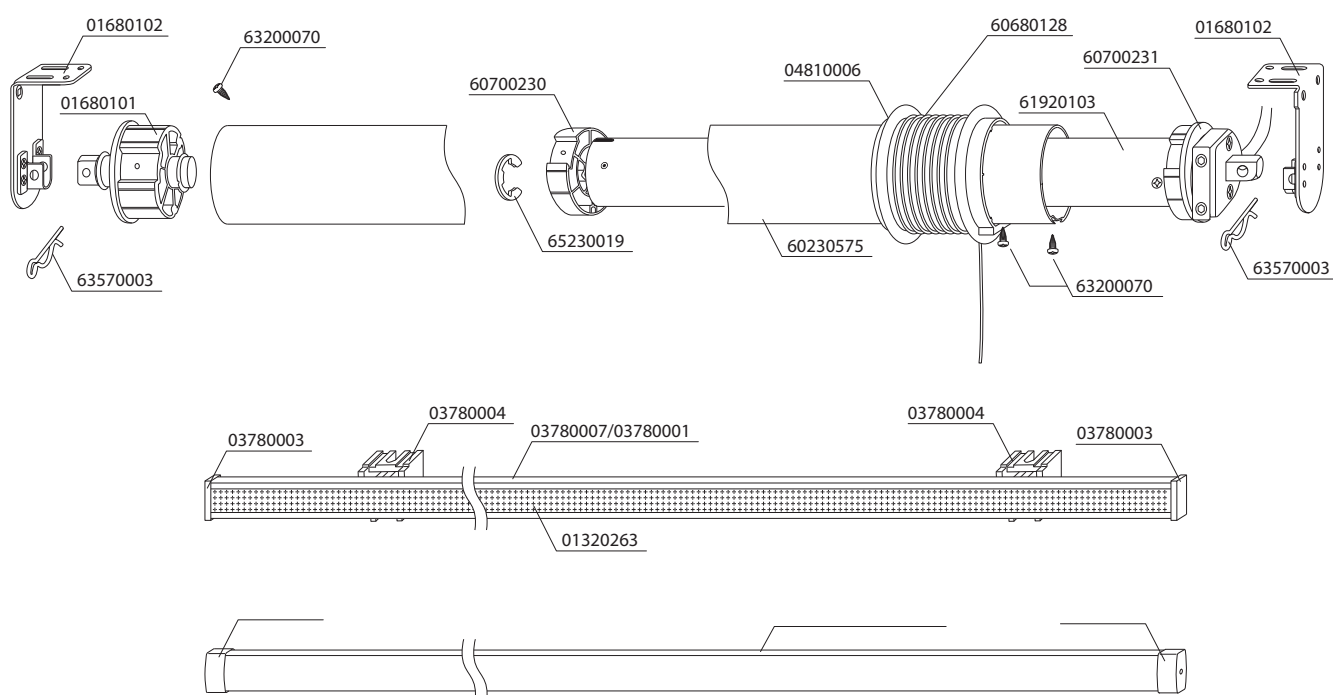



Vue éclatée

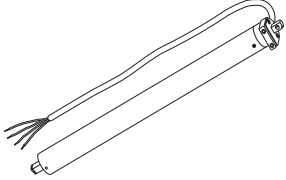

Composants et quantité

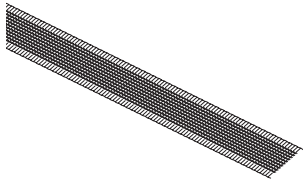
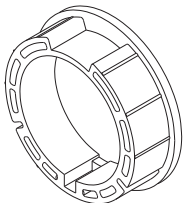
Référence	Description	Largeur produit			
		700-900 mm (28-35")	910-1400 mm (36-55")	1410-1900 mm (56-75")	1910-2000 mm (75-79")
61920103	ATF35 Moteur	1 pc			
60700231	ATF35 Couronne moteur	1 pc			
60700230	ATF35 Couronne guide	1 pc			
01680101	ATF35 Embout	1 pc			
60230575	ATF35 Tube ø 50 mm	L - 62 mm (2.4") x 1 pc			
01680102	ATF35 Support	2 pcs			
63570003	ATF Aiguille de connection	2 pcs			
65230019	ATF Anneau de blocage	1 pc			
63200070	Vis 3 x 10	2 pcs			
03780004	Freel Support	2 (L) 700-800 mm /28-32")	3 (L: 810-1400 mm /32-55")	4 (L: 1410-2000 mm /56-79")	
03780007/03780001	Freel profil	L - 4 mm (.16") x 1 pc			
03780003	Freel Embout	2 pcs			
01320263	Ruban agrippant	L - 4 mm (.16") x 1 pc			
04810006	ATF35-RS Bobine	3 pcs	4 pcs	5 pcs	6 pcs
01320275	Cordon d'élévation ø 1.2 mm	3 pcs x 4 m (158")	4 pcs x 4 m (158")	5 pcs x 4 m (158")	6 pcs x 4 m (158")
01030265	Embout barre de charge	2 pcs			
MTWBST	Barre de charge	L - 50 mm (2.0") x 1 pc			

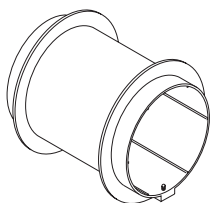
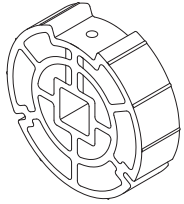
ATF35-RS - Accessoires

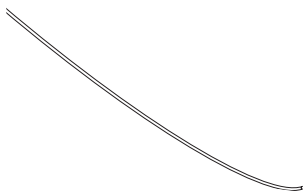
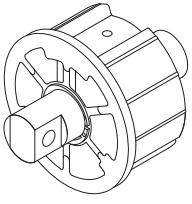
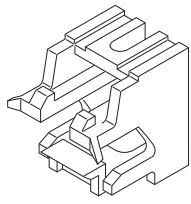
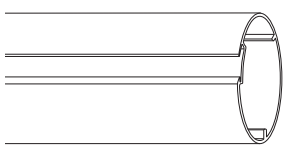
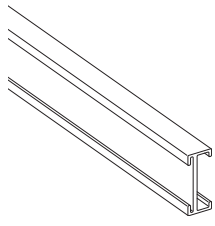
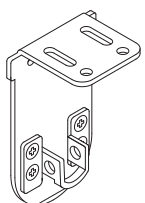
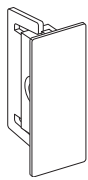
Description	Référence	Description	Référence	Description	Référence
ATF35 Moteur 	61920103	ATF35 Aiguille de connection 	63570003	Ruban agrippant 	01320263
ATF35 Couronne moteur 	60700231	ATF35 Anneau de blocage 	65230019	ATF35-RS Bobine 	04810006
ATF35 Couronne guide 	60700230	Vis 3x10 	01030250	Cordon d'élévation ø 1.2 	01320275
ATF35 Embout tube 	01680101	FREEL Support 	03780004	Embout barre de charge	
ATF35 Tube ø 50 	60230575	Freel profil 	03780007 03780001	Barre de charge	
ATF35 Support 	01680102	Freel Embout 	03780003		