

Paroi Japonaise Classique



Mécanisme de paroi japonaise décliné de 2 à 5 voies.

Assemblage et finition très simple, disponible en manoeuvre libre ou à entrainement sur mesure. Les accessoires sont disponibles pour l'adapter pour une manoeuvre par tirage cordon.

Section des profils

Profil 2 voies

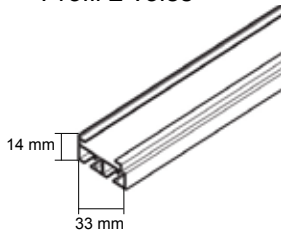

Porte-toile

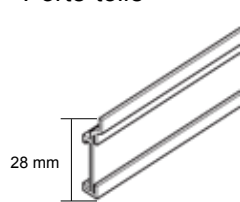

Profil 3 voies

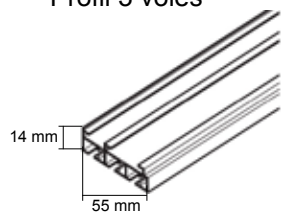

Profil 4 voies

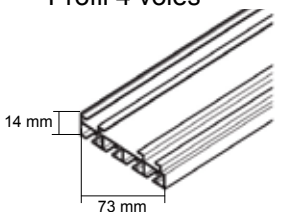

Profil 5 voies

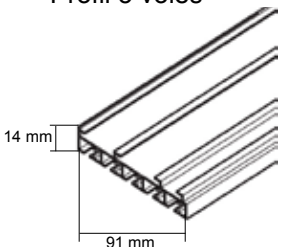

Placement des supports et poids supporté

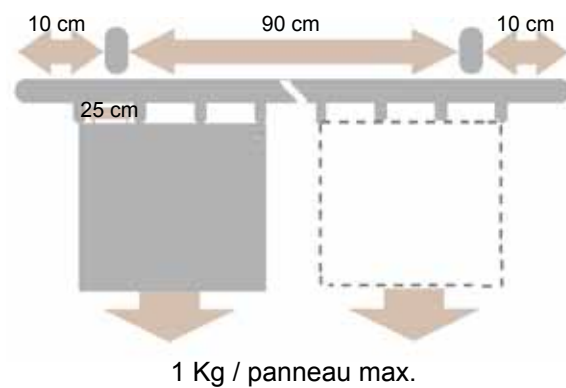

Assemblage

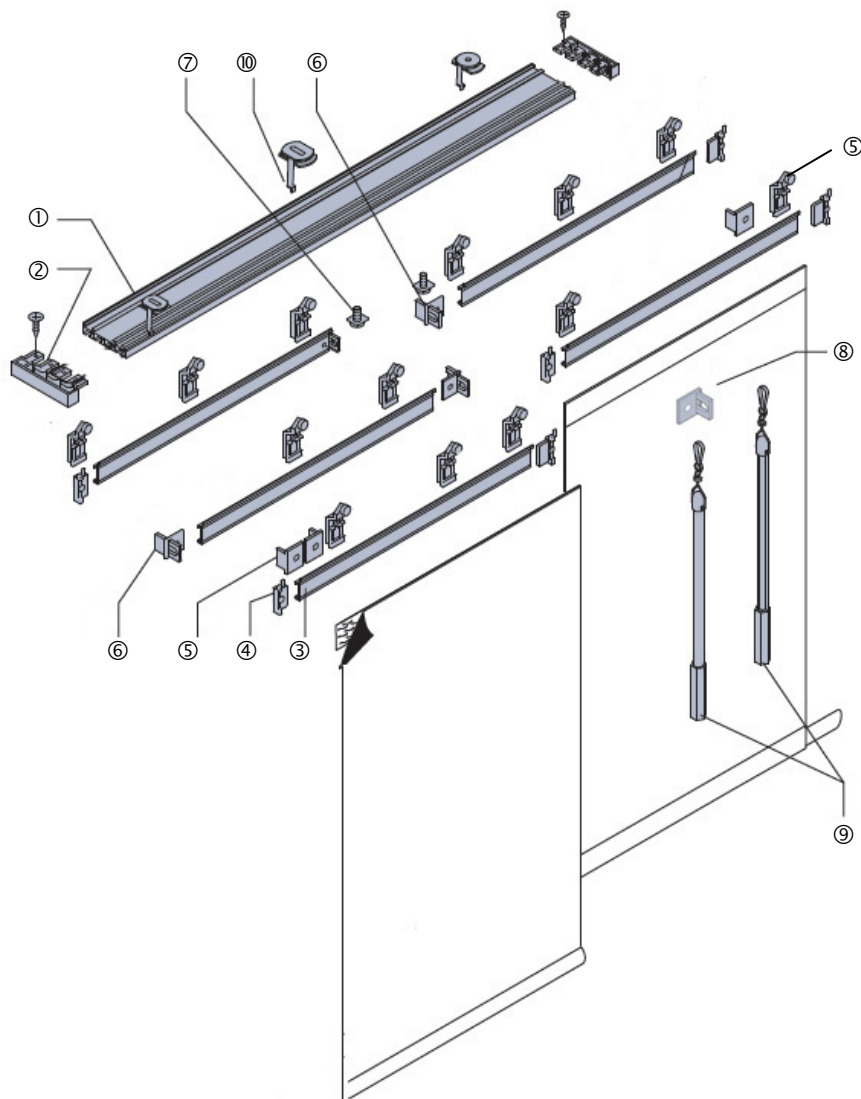

Posez le glisseur accrochez dans le rail



Faites pivoter le glisseur à 90° dans le rail

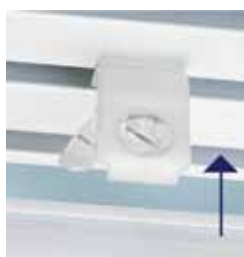

Posez le porte-toile dans le glisseur



Fixez le glisseur dans le porte-toile









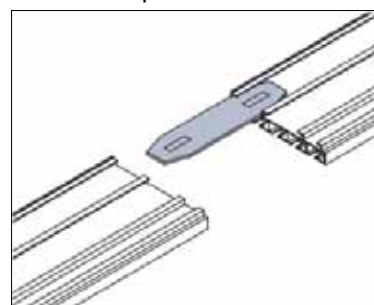





Le glisseur est fixé

①	Profil
②	Embout profil
③	Porte-toile
④	Embout porte-toile
⑤	Butée simple
⑥	Butée d'entraînement porte-toile
⑦	Arrêt
⑧	L-connecteur et support lance-rideau
⑨	Lance-rideau (option)
⑩	Support plafond

Racord de profil



Accessoires

Decription	Référence	Decription	Référence
Profil 2 voies Laqué blanc - Long 6,00 m 	PJC02006	Embout porte-toile Droite et gauche 	PJC00040
Profil 3 voies Laqué blanc - Long 6,00 m 	PJC03007	L-connecteur et support lance-rideau 	PJC00015
Profil 4 voies Laqué blanc - Long 6,00 m 	PJC04008	Butée d'entrainement pour porte-toile 	PJC00016
Profil 5 voies Laqué blanc - Long 6,00 m 	PJC05009	Butée simple 	PJC00017
Porte-toile Blanc 	PJCPT014	Support plafond 2/3 voies 	PJC00010
Glisseur clipsable pivotant 	PJC00055	Support plafond 4/5 voies 	PJC00011
Embout profil 2 voies	PJC00041		
Embout profil 3 voies	PJC00042		
Embout profil 4 voies	PJC00043		
Embout profil 5 voies	PJC00044		